

CC/CV Mode Synchronous Step-Down Converter

DESCRIPTION

The EUP3270 is a synchronous step-down converter capable of driving 4A continuous load with excellent line and load regulation. The EUP3270 operates in either CC (Constant Current) mode or CV (Constant Voltage) mode with an input voltage range from 4.5V to 30V. The EUP3270 provides programmable cable compensation by adjusting external resistor divider. External shutdown function can be controlled by pulling COMP pin to a level below 0.14V.

Fault protection includes secondary cycle-by-cycle current limit, short circuit protection and thermal shutdown. Internal soft-start minimizes the inrush supply current and the output overshoot at initial startup.

The EUP3270 is available in SOP-8 (EP) package.

FEATURES

- 4.5V to 30V Wide Input Operating Range
- 80kHz~400kHz Switching Frequency Selection
- CC/CV Mode Control
- Up to 4A Output Current
- +/- 1.5% Voltage Reference Accuracy
- +/- 4% Constant Current Accuracy
- Programmable Cable Compensation
- Internal Soft Start
- Single Pin to External Compensation and Shutdown Control
- Hiccup Short Circuit Protection
- Secondary Cycle-by-Cycle Current Limit
- Thermal Shutdown
- Available in SOP-8 (EP) Package
- RoHS Compliant and 100% Lead(Pb)-Free Halogen-Free

APPLICATIONS

- Car Charger
- Portable charger applications
- DC/DC converters with current limited

Typical Application Circuit

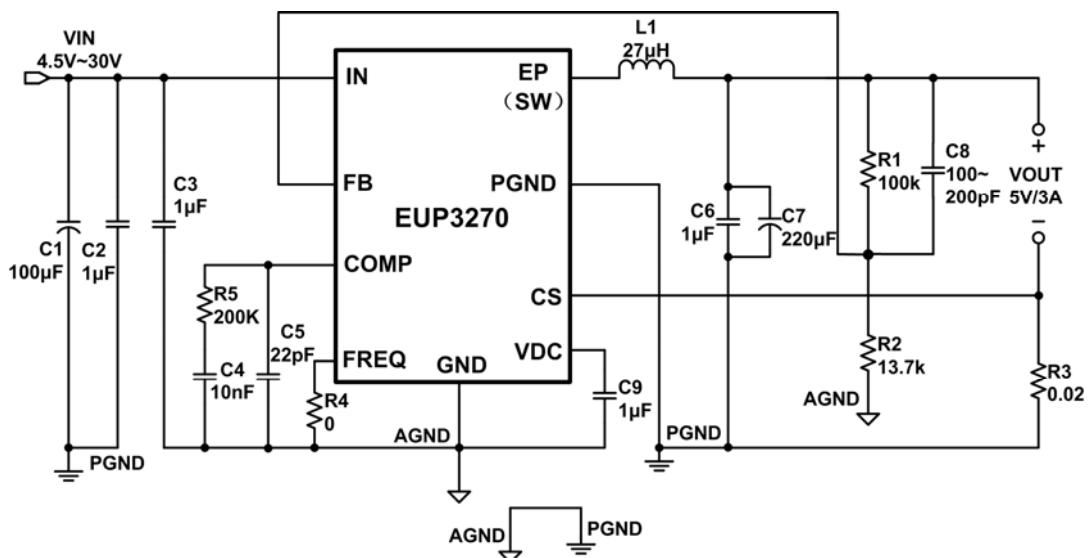

Figure 1. 150KHz Operating Frequency Application Circuit